



Install
Sound



IL 118 Sub

This high-performance, direct-loaded subwoofer delivers powerful, low-ranging and dynamic bottom-end response. Designed to reinforce fullrange cabinets with enhanced low-frequency performance, the IL 118 Sub

is well-suited for installation in dance clubs, live venues and theaters.

It is ideal for augmenting HK AUDIO® IL 12.1, IL 12.2, IL 15.1 and IL 15.2 cabinets.

The IL 118 Sub is a subwoofer geared to extend the low-range frequency response of HK AUDIO® IL 12.1, IL 12.2, IL 15.1, and IL 15.2 cabinets. It is loaded with a direct-radiating 18" conical loudspeaker housed in a bass reflex enclosure.

The IL 118 Sub's hallmarks are powerful low-end performance and dynamic response. Depending on sound pressure requirements, it is a superb option for sound reinforcement applications demanding

enhanced low-end performance for medium- to long-throw coverage.

The IL 118 Sub must be operated in combination with an outboard active crossover or a hi-cut filter. For the greatest operating safety, best performance and most convenient handling, we recommend using the HK AUDIO® Digital Field Controller (DFC).

Architectural specifications

The professional subwoofer enclosure shall be loaded with an 18" bass speaker mounted in a rectangular precision-tuned bass reflex housing constructed of 19 mm-thick MDF and coated with either black or white acrylic paint. The speaker shall be protected by an impact-resistant steel grille padded with glued-on acoustic foam. The enclosure shall incorporate flush-mounted M6-style threaded bushings which will accept optionally available casters.

The frequency response of the subwoofer shall extend from 46 Hz to approximately 250 Hz (+/- 3 dB). Axial sensitivity shall measure 102 dB @ 1W/1m under half-space conditions. Maximum sound pressure level shall be 128 dB at 10% THD under half-space

conditions. The subwoofer shall have a power-handling capacity of 400 watts RMS, and an impedance of 8 ohms.

There shall be two types of input connectors: one Neutrik NL 4 Speakon® connector, and one pair of binding posts.

The exterior dimensions shall be 71.7 cm wide x 51.8 cm tall x 70 cm deep, and the unit shall weigh 38 kg (83.6 lbs).

A set of 100-mm casters (4" wheels) shall be available as an option.

The subwoofer shall be the HK AUDIO model **IL 118 Sub**.

- black: G 182013
- white: G 182043

Enclosure design and mechanical appointments

The IL 118 Sub's housing is made of 19-mm MDF coated with acrylic enamel. Cabinets ship in the standard colors black or white. The enclosure is shaped in a rectangular block. Covering its front baffle is an impact-resistant steel grille backed with laminated acoustic foam rubber. Four rubber stops on the bottom panel hold the cabinet securely in place. The rubber pads may also be attached to the side panel for greater setup flexibility. Located on the back of the IL 118 Sub are countersunk M6 bits threaded to accept optionally available casters.

The IL 118 Sub weighs 38 kg. It is 51.8 cm wide, 71.7 cm high and 70 cm deep. Connectors are located on a countersunk panel on the back of the IL 118 Sub. This panel offers a four-pin Speakon® port. The IL 118 Sub's pin assignments are pin 1+ / pin 1- (wired in parallel with pin 2+ / pin 2-).

The IL 118 Sub is also equipped with parallel-wired binding posts allowing the use of speaker cords lacking plugs.

Electrical and acoustical data

The IL 118 Sub features an 18" conical chassis speaker. Its frequency response ranges from 37 Hz to approximately 250 Hz. The IL 118 Sub's nominal power handling capacity is 400 watts RMS at 8 ohms impedance. It delivers 102 dB SPL (1W/1m), measured under half-space conditions.

Maximum SPL measured under the same conditions at a distance of one meter is 128 dB at 10% THD.

Measurement charts

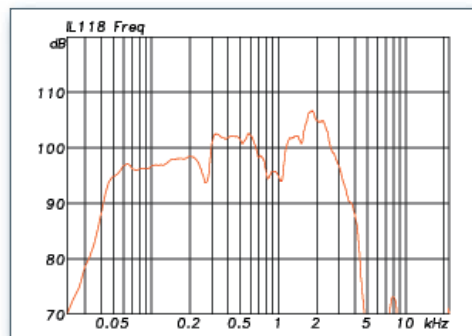

Frequency Response

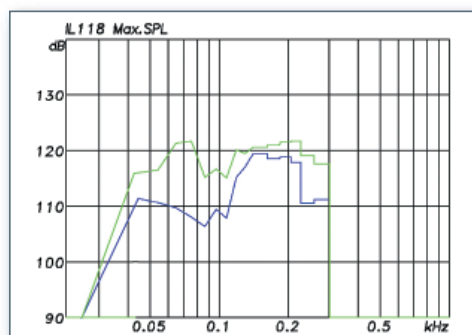

Max. SPL

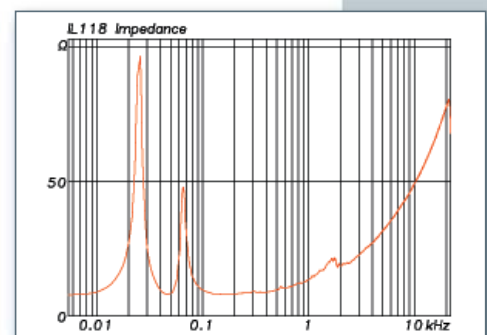

Impedance

Complementary fullrange enclosures suitable for use as mid/ high cabinets

The following HK AUDIO® Installation Line fullrange enclosures are well-suited for supplementing the IL 118 Sub subwoofer:

IL 12.1

A two-way, fullrange cabinet geared for high-quality voice and music reinforcement in theaters, pubs, sports arenas and multipurpose halls, clubs, etc., the IL 12.1 may be deployed as a

fullrange or mid-/high-range cabinet in combination with the HK AUDIO® subwoofers IL 115 Sub, IL 118 Sub or IL 218 Sub. It is the first-choice enclosure for assertive, clear speech

and music reinforcement for short- to medium-throw applications. Passive crossover on board.



IL 12.2

Tuned for voice and music applications, this fullrange cabinet offers extraordinary phase linearity, highest speech intelligibility, and considerable dynamic range.

The IL 12.2 may be deployed as a fullrange or mid-/high-range cabinet in configurations with a subwoofer such as the IL 118 Sub. It is the consummate cab for voice

and music applications demanding high sound pressures levels. Passive crossover on board.



IL 15.1

This fullrange cabinet delivers enhanced low-end response and considerable power handling capacity for high-quality voice and music sound reinforcement in bars, live venues, smaller

clubs, theaters, and so forth. The IL 15.1 may be deployed as a fullrange or mid-/high-range cabinet in combination with the HK AUDIO® subwoofers IL 115 Sub, IL 118 Sub or

IL 218 Sub. Packing a mighty punch and rendering voices and music with utmost clarity, this cab is ideal for short- to medium-throw applications. Passive crossover on board.



IL 15.2

Designed for voice and fullrange applications, this cabinet's extraordinary phase linearity, highest speech intelligibility, and great dynamic range with powerful low-end response predestine it for use in theaters, sports

and multipurpose arenas, live venues, clubs, etc. The IL 15.2 may be deployed as a fullrange or a mid-/high-range cabinet in configurations with a subwoofer such as the HK AUDIO® IL 118 Sub or

IL 218 Sub. It is the consummate choice for voice and music applications demanding high sound pressures levels with enhanced low-end performance. Passive crossover on board.



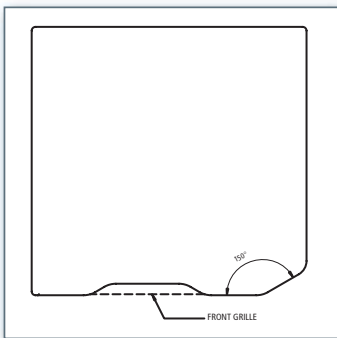
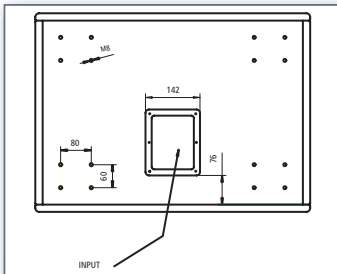
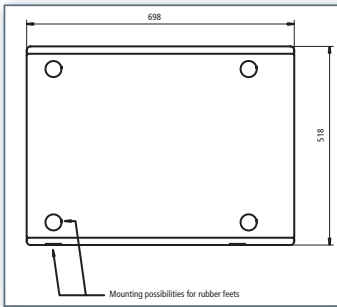
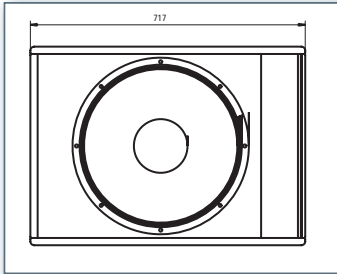

Technical specifications

Loudspeakers

Power handling nominal (RMS):	400 W
Power handling (program):	800 W
Power handling (peak, 10 ms)	1600 W
Impedance:	8 ohms
Frequency response (± 3 dB):	46 Hz to approximately 250 Hz
Frequency response (-10 dB):	37 Hz to approximately 250 Hz
Axial sensitivity (1W/1m, half-space):	102 dB
Maximum SPL (3 % THD, half-space):	126 dB
Maximum SPL (10% THD, half-space):	128 dB
Maximum SPL (calculated at peak):	134 dB
Woofer:	18"

Connectors

Ports:	1 Speakon® NL4, 1 set of binding posts
Pin assignments:	Speakon: 1+ / 1- wired in parallel with 2+ / 2-

Housing

Material:	19 mm MDF
Coating:	black or white acrylic enamel
Front cover:	impact-resistant protective steel grille
Fittings:	M6 threaded bits for attaching optionally available casters
Weight:	38 kg / 83.8 lbs.
Dimensions (W x H x D):	71.7 x 51.8 x 70 cm

Accessories

- 100 mm casters

Service items

- 18" speaker



HK AUDIO® • Postfach 1509 • 66595 St. Wendel • Germany • International Inquiries: fax +49-68 51-905 215
international@hkaudio.com • www.hkaudio.com

